

Article number: 20806031

Description: E+G Spherical washer, female
DIN 6319-35-D

Measures

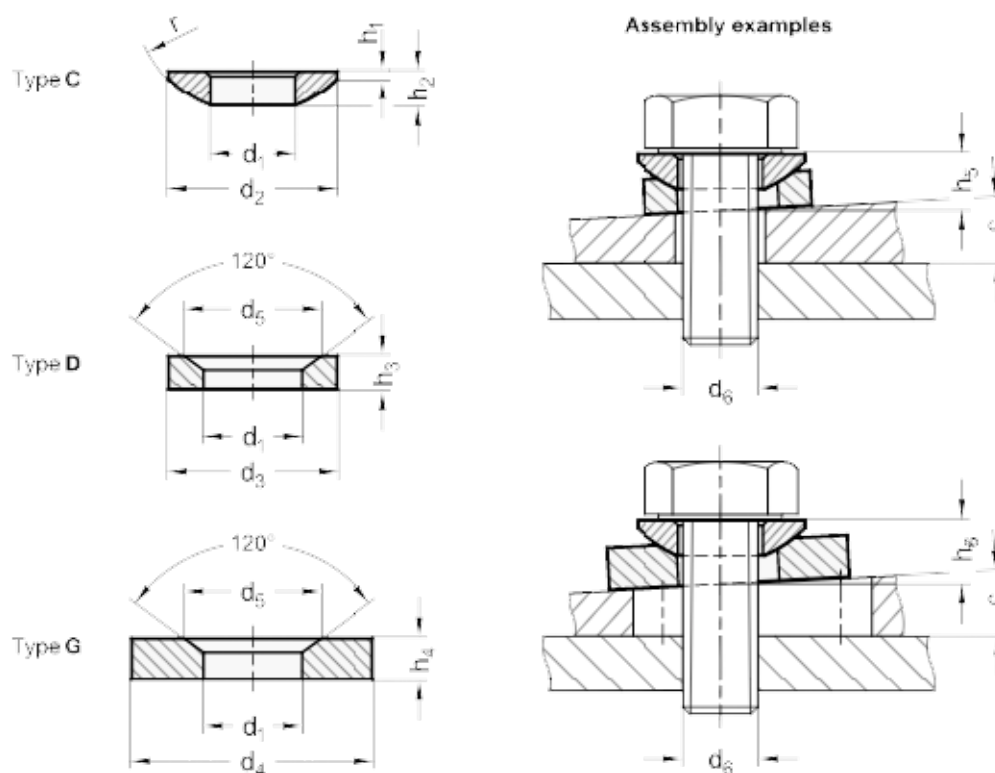

$d_2 = 35.0$

$d_4 = 56$

$d_5 = 49.0$

$d_6 = M30$

$H_3 = 12.0$

$H_4 = 19.2$